

RADIODETECTION®

RD8200® SG

Multifunction precision
cable and pipe locator

User Guide

90/RD8200SG-UG-ENG/01



Preface

About this guide

CAUTION: This guide provides a quick introduction to the RD8200®SG locator and Tx range of transmitters. It is intended to provide general advice and does not constitute professional training. It also contains important safety information and guidelines and as such should be read in its entirety before attempting to operate the RD8200SG locator and transmitter. To enquire about training, please contact your local Radiodetection representative.

For detailed instructions on all the features for the RD8200SG and Tx range of transmitters, including the use of accessories, please refer to the RD8200SG operation and RD Manager™ Online manuals, which are available for download from www.radiodetection.com.

The online User Manual library also contains links to the RD Manager Online manuals. Certificates of conformity for the RD8200SG locators and Tx transmitter ranges can be found at www.radiodetection.com.

⚠ WARNING! Direct connection to live conductors is POTENTIALLY LETHAL. Direct connections to live conductors should be attempted by fully qualified personnel only using the relevant products that allow connections to energized lines.

⚠ WARNING! The transmitter is capable of outputting potentially lethal voltages. Take care when applying signals to any pipe or cable and be sure to notify other technicians who may be working on the line.

⚠ WARNING! Reduce audio level before using headphones to avoid damaging your hearing.

⚠ WARNING! This equipment is NOT approved for use in areas where hazardous gases may be present.

⚠ WARNING! When using the transmitter, switch off the unit and disconnect cables before removing the battery pack.

⚠ WARNING! The RD8200SG locator will detect most buried conductors but there are some objects that do not radiate any detectable signal. The RD8200SG, or any other electromagnetic locator, cannot detect these objects so proceed with caution. There are also some live cables which the RD8200SG will not be able to detect in Power mode. The RD8200SG does not indicate whether a signal is from a single cable or from several in close proximity.

⚠ WARNING! Batteries can get hot after prolonged use at full output power. Take care while replacing or handling batteries.

⚠ WARNING! Only use charging equipment provided by Radiodetection. The use of alternative chargers may cause a safety hazard and/or reduce the life of the battery.

CAUTION: Do not let your battery completely discharge as this may reduce its life or damage it permanently. If you are not using your equipment for a long period charge them at least once a month.

⚠ WARNING! Do not tamper with, or attempt to disassemble the battery packs.

CAUTION: If battery failure is suspected or if the battery shows any sign of discoloration/physical damage return the entire unit to an authorized repair center for investigation and repair. Local, national or IATA transport regulations may restrict the shipment of faulty batteries. Check with your courier for restrictions and best practice guidelines. Your local Radiodetection representative will be able to direct you to our authorized repair centers.

NOTE: The charging temperature range is 0 to 45 °C, 32 to 113°F. Do not attempt to recharge your batteries outside this temperature range.

3 Year Extended Warranty

RD8200SG locators and transmitters are covered by a 1 year warranty as standard. Customers can extend their warranty period to a total of 3 years by registering their products within 3 months of purchase.

To register your product:

Visit <https://portal.radiodetection.com> to create your portal account* and use the Product page to register your locator or transmitter.

Visit <https://support.radiodetection.com> for instructions on how to create a portal account or register your product.

* A valid email address and mobile number are required.

eCert and Self-Test

The RD8200SG locator is safety equipment which should be regularly checked to ensure its correct operation.

eCert provides a thorough test of the RD8200SG's locating circuitry, and supplies a Radiodetection Calibration Certificate when a positive test result is obtained.

To run an eCert, the locator should be connected to an internet-enabled PC on which the RD Manager Online software is installed.

Refer to the RD Manager Online operation manual for further details. Additional purchase may be required.

RD8200SG locators incorporate an Enhanced Self-Test feature. In addition to the typical checks for display and power functions, the RD8200SG applies test signals to its locating circuitry during a Self-Test to check accuracy and performance.

We recommend that a self-test is run at least weekly, or before each use.



Scan the QR code or visit:
<https://support.radiodetection.com>
to access our Technical Support portal.

RD8200SG locator

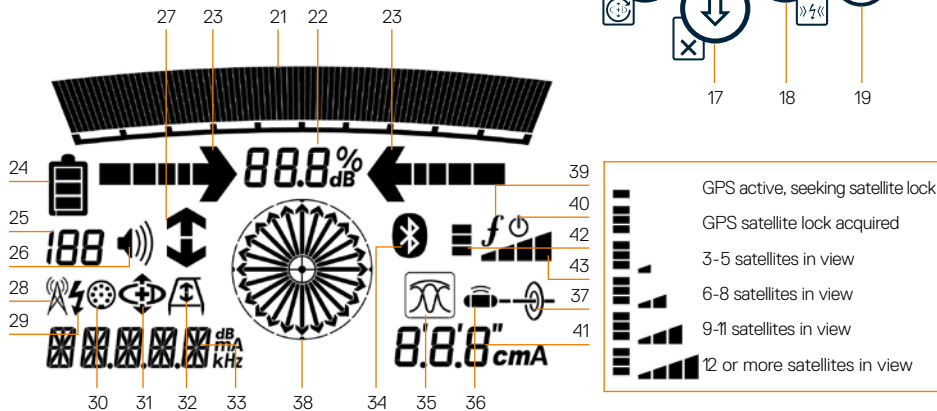
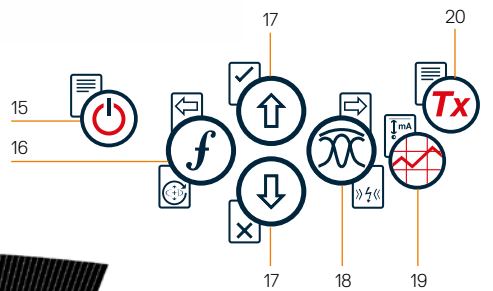

Locator features

- GNSS antenna.
- Cold shoe mount for mobile device bracket (fitted on both sides).
- Haptic (vibration) feedback.
- Speaker.
- Swing alert system.
- Lithium-Ion battery pack.
- Accessory connector.
- Headphone connector.
- Bluetooth® modules.
- Green LED light to indicate RTK status: off, float or fix.
- LCD with auto backlight.
- Keypad.
- Bubble.
- USB port (inside battery compartment).
- Battery level.
- Sensitivity readout / Log number.
- Volume level.
- Current Direction arrows.
- Radio Mode icon.
- Power Mode icon.
- Accessory connection icon .
- CD Mode icon.
- A-Frame icon.
- Frequency / current / menu readout.
- Bluetooth status icon:
Flashing icon means pairing is in progress. Solid icon indicates a connection is active.
- Antenna mode icon:
Indicates antenna mode selection: Peak / Null / Broad Peak / Peak+™ / Guidance.
- Sonde icon: Indicates that a sonde signal source is selected.
- Line icon: Indicates that a line signal source is selected.
- Compass: Shows the orientation of the located cable or sonde relative to the locator.
- Transmitter communication status – confirms successful iLOC™ communication.

Locator keypad

- Power key.
- Frequency key.
- Up and down arrows.
- Antenna key.
- Survey key.
- Transmitter key.

Locator screen icons

- Signal strength bargraph with peak marker.
- Signal strength readout.
- Null / Proportional Guidance arrows.
- Battery level.
- Sensitivity readout / Log number.
- Volume level.
- Current Direction arrows.
- Radio Mode icon.
- Power Mode icon.
- Accessory connection icon .
- CD Mode icon.
- A-Frame icon.
- Frequency / current / menu readout.
- Bluetooth status icon:
Flashing icon means pairing is in progress. Solid icon indicates a connection is active.
- Antenna mode icon:
Indicates antenna mode selection: Peak / Null / Broad Peak / Peak+™ / Guidance.
- Sonde icon: Indicates that a sonde signal source is selected.
- Line icon: Indicates that a line signal source is selected.
- Compass: Shows the orientation of the located cable or sonde relative to the locator.
- Transmitter communication status – confirms successful iLOC™ communication.
- Transmitter standby indicator.
- Depth readout.
- GPS Status.
- GPS Signal quality.

Tx-5 and Tx-10 transmitters

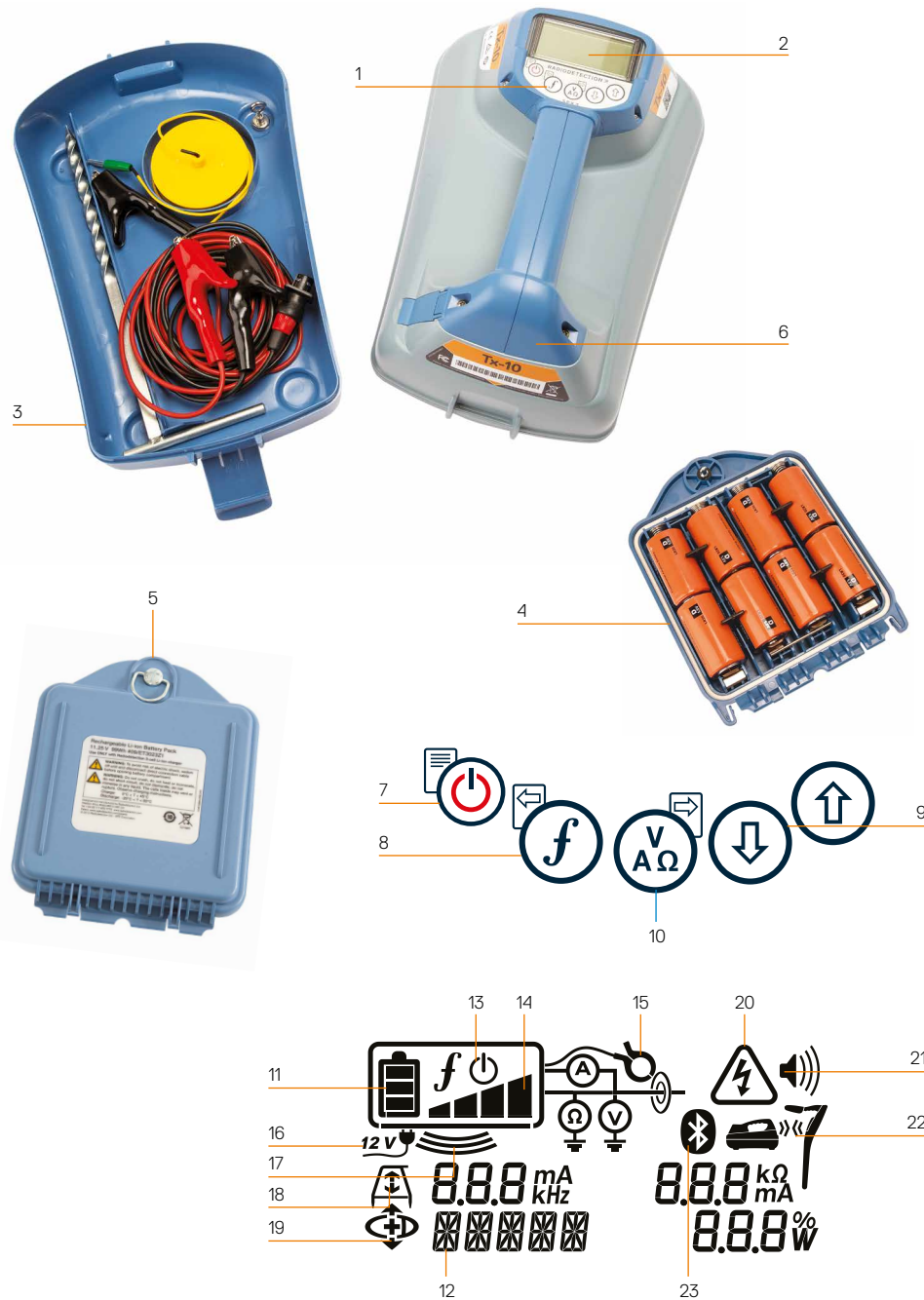

Transmitter features

1. Keypad.
2. LCD.
3. Removable accessory tray.
4. D-cell battery tray.
5. Optional Lithium-Ion battery pack.
6. Bluetooth module (iLOC units).
15. Clamp icon: Indicates when a signal clamp or other accessory is connected.
16. DC Power connected indicator.
17. Induction mode indicator.
18. A-Frame: Indicates when the transmitter is in Fault-Find Mode.
19. CD Mode: Indicates that the transmitter is in Current Direction Mode.
20. Voltage warning indicator: Indicates that the transmitter is outputting potentially hazardous voltage levels.
21. Volume level indicator.

Transmitter keypad

7. Power key.
8. Frequency key.
9. Up and down arrows.
10. Measure key.

Transmitter screen icons

11. Battery level indicator.
12. Operation mode readout.
13. Standby icon.
14. Output level indicator.

iLOC enabled transmitters only:







22. Pairing icon: Appears when the transmitter and locator are connected via iLOC.
23. Bluetooth icon: Indicates status of Bluetooth connection. Flashing icon means pairing is in progress.









Keypad actions and shortcuts



Switch the locator or transmitter on by pressing the  key. Once powered up, the keys function as follows:

Locator keys

Key	● Short press	▬ Long press
	Enter the menu.	Switch power off.
	Scroll through locate frequencies from low to high.	SideStep.™ When using Current Direction™: Perform a CD Reset.
	When using active frequencies: Toggles Peak, Peak+, Null, Broad Peak and Guidance antenna modes. In Power Mode: Scrolls through Power Filters™ for improved discrimination of parallel or strong power signals.	In Peak+ antenna mode: Switch between Guidance and Null arrows.
	Increase and decrease gain. RD8200SG automatically sets gain to mid-point when pressed.	Rapidly increase and decrease gain steps in 1dB increments.
	Take a Survey Measurement and send over Bluetooth if paired.	-
	Send an iLOC command to a paired transmitter.	Enter the Transmitter power setting menu for use over iLOC.

Transmitter keys

Key	● Short press	▬ Long press
	Enter the menu.	Switch power off.
	Scroll through locate frequencies from low to high.	-
	Take voltage and impedance measurements using the currently selected frequency.	Take voltage and impedance measurements at a standardized frequency
	Adjusts the output signal.	Select standby  / maximum standard power 

Tip: to scroll through frequencies from high to low, hold  while pressing the  button (applies to both locators and transmitters).

Before you begin

Before you start using the RD8200SG, make sure you have the following:

- RD8200SG locator with fully charged Lithium-Ion pack.
- Tx Transmitters with fully charged Li-Ion pack or batteries.
- Mobile phone with compatible mobile app subscription.
- Correction service provider details.

For help on compatible mobile apps and correction service providers, please visit our [RD8200SG technical support page](#).

First use

The RD8200SG locator is powered by the Lithium-Ion rechargeable battery pack. The transmitter is powered by the optional Lithium Ion rechargeable battery pack, or D-Cell batteries.

The RD8200SG will automatically set the battery type to Lithium-Ion. The correct battery type must be set for the transmitter using the menu options.

Fitting rechargeable battery packs

The RD8200SG locator comes with the Lithium-Ion battery pack fitted. You may need to connect the Li-Ion lead (see instruction 8). To remove and re-fit the rechargeable packs, follow the instructions below.

Locator battery packs

To remove:

1. Unclip the latch at the top of the battery pack.

2. Lift the battery pack.
3. Lift the accessory flap and press the retaining flap inwards.

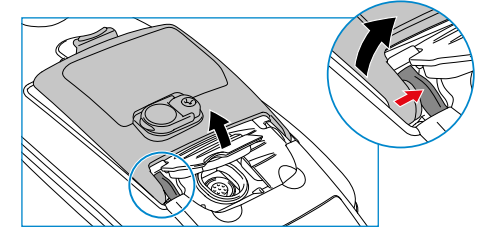

4. Do the same on the other side.
5. Disconnect the lead and remove pack.

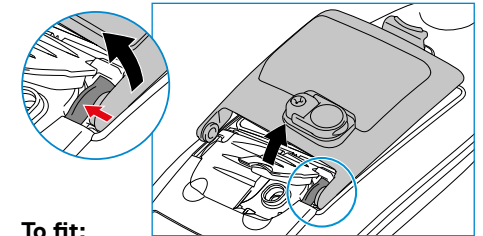

To fit:

6. Lift the accessory flap, press the retaining flap inwards and insert pack to that side.
7. Do the same on the other side.

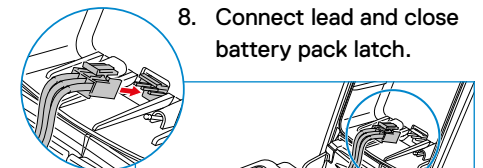
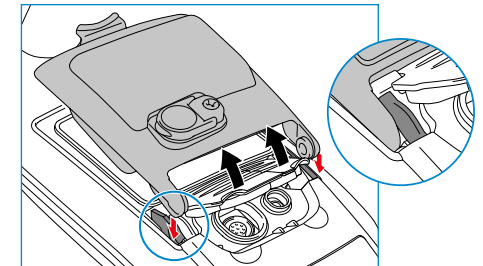

8. Connect lead and close battery pack latch.

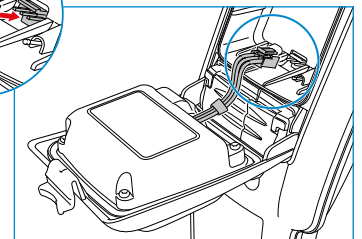

Transmitter battery packs

1. Release clips then remove the accessory tray

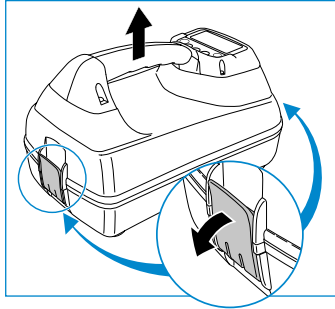

2. Open the battery compartment by rotating the metal clip clockwise

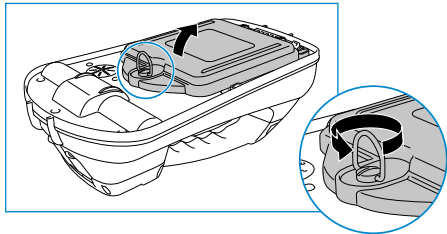

3. Press the release catch and lift the battery pack away

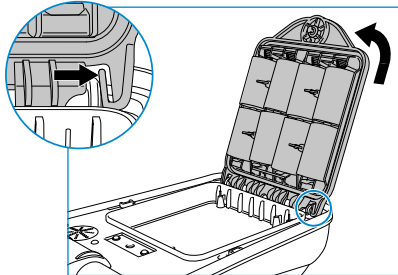

4. Line up the battery pack and press into position

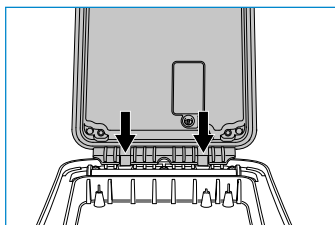

Charging the battery packs

⚠ WARNING! Only use charging equipment provided by Radiodetection. The use of alternative chargers may cause a safety hazard and/or reduce the life of the battery.

CAUTION: Do not let your battery completely discharge as this may reduce its life or damage it permanently. If you are not using your equipment for a long period charge them at least once a month.

⚠ WARNING! Batteries can get hot after prolonged use at full output power. Take care while Replacing or handling batteries.

⚠ WARNING! Do not tamper with, or attempt to disassemble the battery packs.

CAUTION: If battery failure is suspected or if the battery shows any sign of discoloration / physical damage return the entire unit to an authorized repair center for investigation and repair. Local, national or IATA transport regulations may restrict the shipment of faulty batteries.

Check with your courier for restrictions and best practice guidelines. Your local Radiodetection representative will be able to direct you to our authorized repair centers.

You can re-charge your batteries using the Radiodetection mains or automotive chargers.

NOTE: The charging temperature range is 0 to 45 °C, 32 to 113°F. Do not attempt to recharge your batteries outside this temperature range.

Pairing Bluetooth Modules

The RD8200SG is fitted with multiple Bluetooth modules. You need to connect to 2 Bluetooth modules to enable survey grade accuracy and send Survey Measurements to your compatible Android device.

1. **GNSS Bluetooth module.**
This Bluetooth module enables survey grade accuracy.
2. **Locator Bluetooth module.**
This Bluetooth module allows you to send locator Survey Measurements to compatible Android devices.

Pairing the GNSS antenna Bluetooth module to an Android device

The GNSS Bluetooth module is always on and does not need to be enabled in the locator.

Switch on the RD8200SG locator.

On your Android device:

1. Navigate to Settings > **Bluetooth**.
2. Ensure that Bluetooth connectivity is switched on.

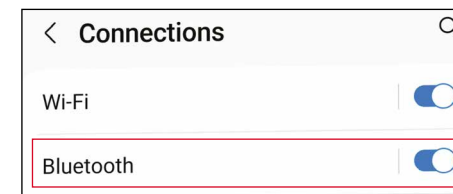

3. **Scan** for a new device to add to the list of paired devices.

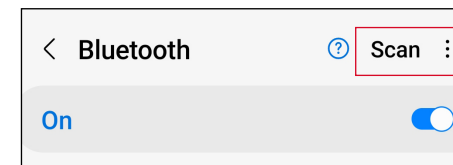

4. Select the RTK82SG-XXXXXX in **Available devices**.



5. When asked for a passkey, enter 1234.

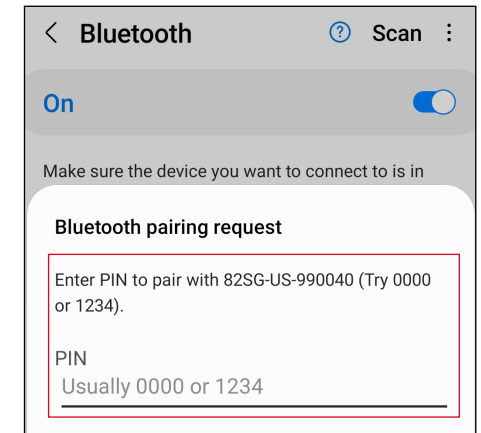

6. RTK-82SG-XXXXXX should now be shown in **Paired devices**.

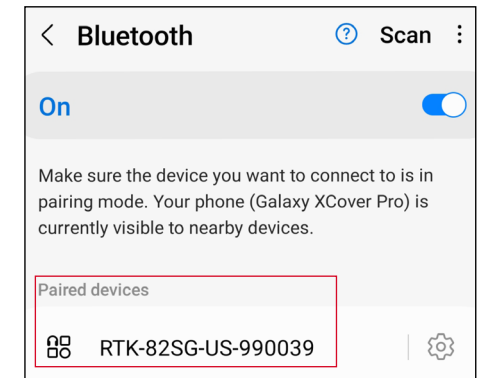

NOTE: If the GNSS Bluetooth module is not advertising, you can reset the Bluetooth module via MENU > GPS > RTK > RESET.

Pairing Locator Bluetooth to Android Device

Please refer to the 'To navigate menus' section on p.21 for assistance.

1. Set unit for pairing mode: Press > > SMLOG > > > PAIR > .
2. Press the key on locator to start pairing cycle.
3. On the Android device, navigate to Settings > Bluetooth.
4. **Scan** for a new device to add to the list of paired devices.

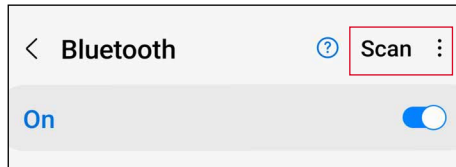

5. Select the 82SG-XXXXXX in **Available devices**.

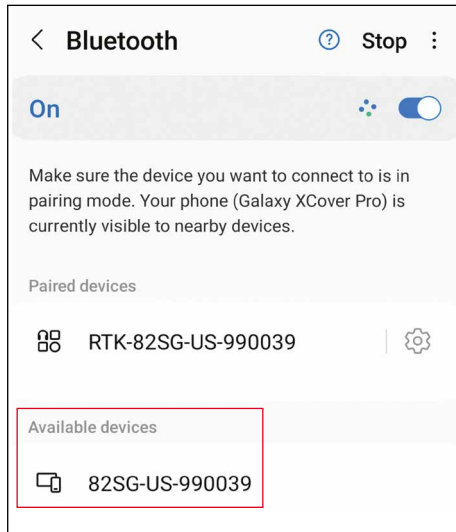

6. When asked for a passkey, enter 1234.

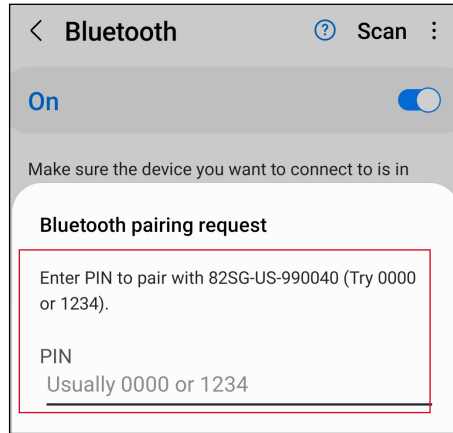

7. 82SG-XXXXXX should now be shown in **Paired devices**.

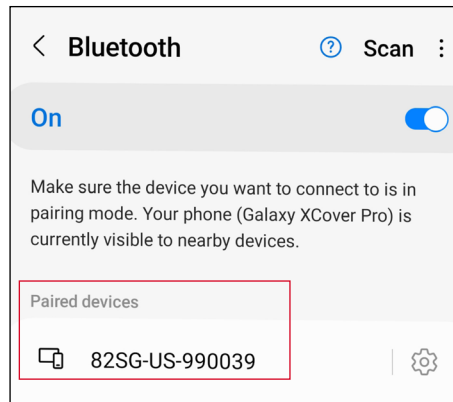

To enable survey grade accuracy, Bluetooth pairing to both the locator and GNSS antenna is required.

Bluetooth error codes

If an error occurs when attempting to perform any Bluetooth command using the locator to the transmitter or the locator to a PC or paired device, the LCD will display a code to help you resolve the problem on the locator.

The codes are as follows:

BT Code	Description
BT001	Bluetooth not configured for this unit.
BT002	Internal Bluetooth error.
BT003	Locator not paired with transmitter.
BT004	Locator not paired with PC/external compatible device.
BT005	Paired but connection attempt failed. Power cycling may be required.
BT006	Corrupt response received from transmitter.
BT007	Indeterminate response received from transmitter.
BT008	No response received from transmitter.
BT010	Transmission to paired device failure.
BT012	No response received from PDA or PC/Phone.
BT014	Paired but connection attempt failed with PC/PDA. Retry or Power cycling may be required.
TX??	Command not supported by transmitter

Survey Measurements

The RD8200SG locator is capable of recording survey measurements and sending them to an external device using Bluetooth. It is important to make sure that the locator settings are set correctly for sending Survey Measurements, compatibility with mobile apps and use of the internal GNSS antenna.

Check locator settings and send Survey Measurements

The settings on the RD8200SG locator should be correct, but it is worth checking the following settings:

1. Ensure your paired device is switched on and running a compatible app, for Android.
2. Check SMLOG COM is ON: SMLOG > COM > ON.
3. Check SMLOG PROT is set to ASCII 2: SMLOG > PROT > ASCII > 2.
4. Check GPS is ON: SMLOG > PROT > ASCII > GPS+ > YES.
5. Check RTK is ON: GPS > RTK > ON.
6. Check MAG_H is ON: INFO > MAG-H > ON.
7. Press the Survey key to store and send Survey Measurement to external device.

Erasing Survey Measurements

The RD8200SG locator allows you to delete all Survey Measurements. Erasing the log will wipe the RD8200SG memory but is usually recommended when you begin a new survey.

NOTE: Erasing Survey Measurements cannot be undone.

1. Set DATA to DEL: SMLOG > DATA > DEL > YES.

⚠ WARNING! Mobile phones or tablets may interfere with the locator's performance if positioned not in either of the cold shoe mounts.

Attaching the phone bracket

The RD8200SG is fitted with a mount on both sides of the locator, to allow for the phone holder to be attached on either side.

1. Slide the square plate on the phone holder down into the bracket. Make sure the wheel is slightly loosened so there is enough room for the phone bracket to slot into place.



2. Once the phone holder is in place, turn the wheel clockwise to fasten and anti-clockwise to loosen.



3. Press the red button on the phone holder to extend the bracket and place your phone in the holder. Squeeze tight to secure the phone in place.

Obtaining RTK fix using a mobile app

To obtain RTK fix and achieve survey grade accuracy, use the mobile app of your choice. Please see [RD8200SG technical support page](#) for compatible apps.

Exact settings will vary per app, please consult the mobile app provider's manual for exact details.

The following instructions relate to the PointMan mapping app. You will need a valid subscription in order to use the app, which can be purchased from Radiodetection.

Instructions for PointMan

1. Open the app and sign in.*
2. Click on New.

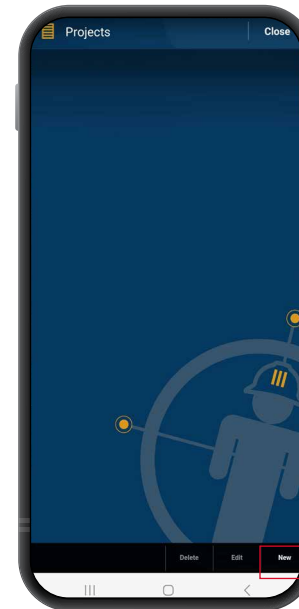

3. Type Project name and click OK.

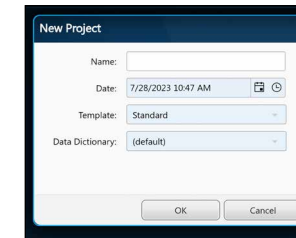

4. You should see a map indicating your location. Click on the menu, top left of the screen.



5. Enter settings from the side menu.

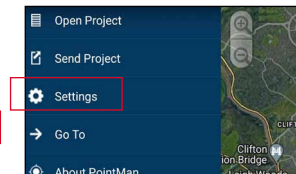

6. Click on Settings.
7. In the devices section, ensure that the BT modules are configured as below, where RTK-82SG-XXXXXX is selected in the 'GPS' menu, and 82SG-XXXXXX is selected in the 'Locator' menu.

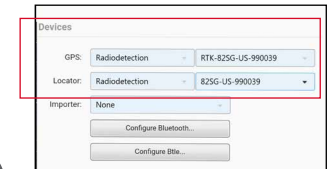

8. Click on the drop down next to GPS and select Radiodetection. Then click on the right drop down menu and select the GNSS Bluetooth module, starting with RTK-82SG.
9. Click on the drop down next to Locator and select Radiodetection. Then click on the right drop down menu and select the locator bluetooth module, starting with 82SG.
10. Check the numbers match the serial number printed on the label of your RD8200SG locator.

*Need to activate your PointMan license? Activation codes for PointMan licenses are printed on the invoice, order confirmation and packing slip.

NTRIP client setup:

1. Click 'Edit' in the 'Correction' section of the GPS menu.

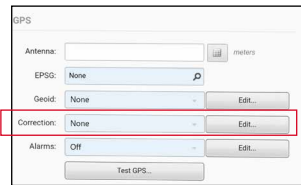

2. Click 'NEW' on the correction profiles pop-up.

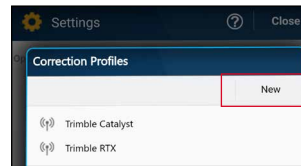

3. Enter your NTRIP client credentials.

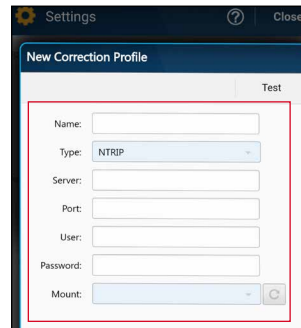

Details will be provided by your correction service provider. They should include:

- Server or Caster IP
- Port
- User
- Password
- Mount point

Please see [RD8200SG technical support page](#) for more information about correction service providers.

4. Click 'Test' to ensure that you have entered the details correctly – you should see an 'OK' to confirm that it has worked.

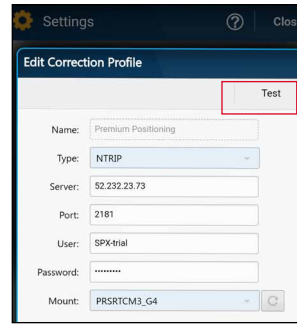

5. Click on the 'Correction' drop down and select the profile you just created

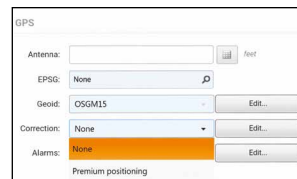

Start a survey and obtaining RTK float/fix

1. Ensure the GNSS device in the locator has access to GNSS satellites (see figure 1b).
2. Select 'NEW' from the top right-hand corner of the app.

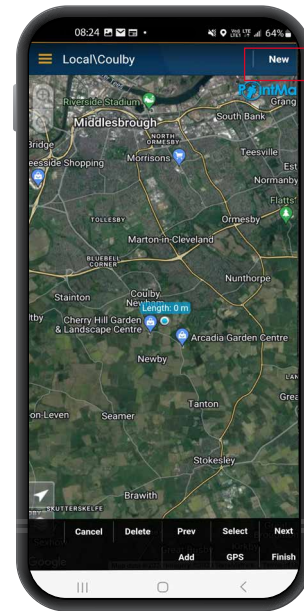

3. Select a utility type.
4. You will now see a box of information in the top right-hand corner of the screen. If after 10-15 seconds 'Diff source' does not appear then you may need to toggle the 'GPS' button near the bottom of the screen.

5. The 'Fix type' field will display values such as GPS, DGPS, RTK float and RTK. The LED on the locator notifies you of RTK float (flashing) and RTK fix (solid).
6. The time to first fix will be longer as the GNSS device is performing a cold start. Find an area that has good visibility of the sky and stand still. This may take up to 15 minutes for the first fix, but will be much quicker for subsequent uses.

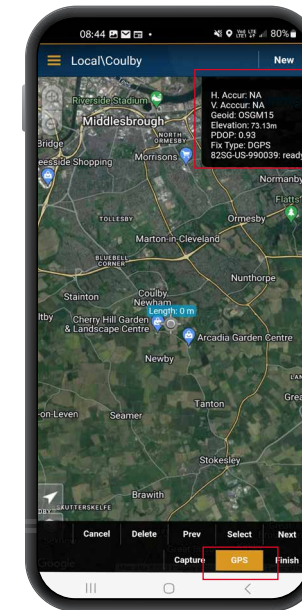

7. Once RTK float/fix has been achieved you can start the survey. If the SM log interface is set up correctly, you'll see it described as 'ready' in the information box.
8. Take Survey Measurement readings by pressing the Survey Measurement button at set intervals or when required. The point should appear in the PointMan app a few seconds later.
9. The RD8200SG is fitted with a level/bubble for ultimate precision. When taking a survey measurement reading, the RD8200SG automatically compensates for the difference between the GNSS antenna position and the foot of the locator. Keep the bubble central for ultimate positional accuracy. Use of the bubble is entirely optional.



Figure 1a. Locator searching for satellites



Figure 1b. Locator identified satellites

Send data from PointMan to email

1. Once you have completed the survey, click 'Finish' in the bottom right hand corner of the app.

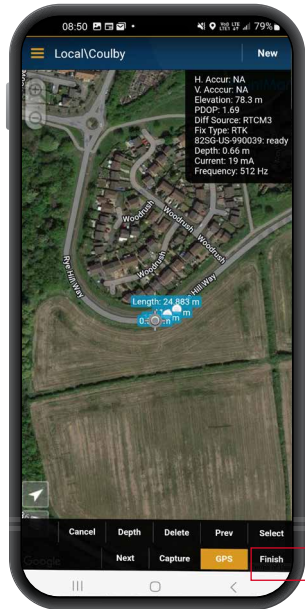

2. Then click on 'Send'.

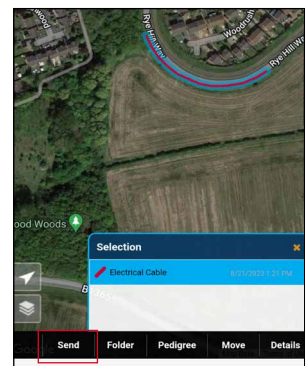

3. Select the survey and select OK on the 'Send' pop-up.

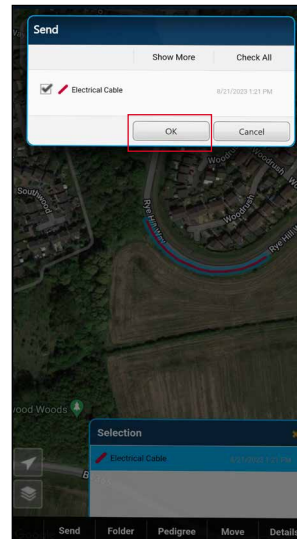

4. Select all of the attachment types and click OK.

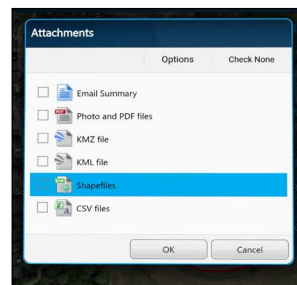

5. Type your email address and send the files.

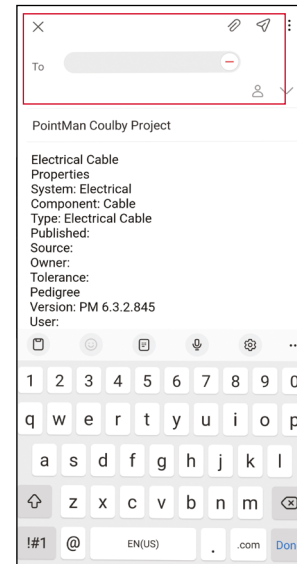

System Menu

The RD8200SG locator and transmitter menus allow you to select or change system options and it is important to set up the system according to regional / operational requirements. Once entered, the menu is navigated using the arrow keys. Navigation is consistent on both the transmitter and the locator. When in the menu, most on-screen icons will temporarily disappear and the menu options will appear in the bottom left-hand corner of the display. The right arrow enters a submenu and the left arrow returns to the previous menu.

Note that when browsing the locator menu, the **F** and **↔** keys act as left and right arrows. When browsing the transmitter menu, the **F** and **V** keys act as left and right arrows.

To navigate menus:

1. Press the **⏻** key to enter the menu.
2. Use the **↑** or **↓** keys to scroll through the menu options.
3. Press the **→** key to enter the option's submenu.
4. Use the **↑** or **↓** keys to scroll through the submenu options.
5. Press the **←** key to confirm a selection and return to the previous menu.
6. Press the **←** key to return to the main operation screen.

NOTE: When you select an option and press the **← key, the option will be enabled automatically.**

Locator menu options

- VOL: Adjust the speaker volume from 0 (mute) to 5 (loudest).
- SMLOG: enable or disable Bluetooth used for sending Survey Measurements, reset

BT, pair with external device, select BT protocol, send stored survey measurement logs and deleting stored logs.

- ILOC: Enable, disable, reset or pair iLoc connections.
- GPS: Disable GPS module, reset GPS, enable or disable BT comms to correction service.
- CDR: Perform a Current Direction (CD) Reset. (Alternatively press and hold the **F** key when in CD mode).
- UNITS: Select metric or imperial units.
- TICKT: Enable or disable ticketing system.
- UTIL: Enable or disable utility selection.
- ULIST: Utility selection.
- LANG: Select menu language.
- POWER: Select local power network frequency: 50 or 60Hz.
- ANT: Enable or disable any antenna mode with the exception of Peak.
- FREQ: Enable or disable individual frequencies.
- ALERT: Enable or disable StrikeAlert™.
- BATT: Li-Ion auto-selects when connected.
- ARROW: Select Null or proportional Guidance arrows in Peak+ mode.
- COMP: Enable or disable display of the Compass feature.
- VALRT: Enable or disable the vibration feature.
- AUDIO: Select High or Low sound levels.
- SWING: Enable or disable Swing measurement.
- INFO: Software version, run Self-Test, display the date of the most recent service recalibration (CAL) or the most recent eCert calibration.

Transmitter menu options

- VOL: Adjust the speaker volume from 0 (mute) to 3 (loudest).
- FREQ: Enable or disable individual frequencies.
- BOOST: Boost transmitter output for a specified period of time (in minutes).
- INFO: Shows the software version
- LANG: Select menu language.
- OPT F: Run SideStep^{auto}™ to auto-select a locate frequency for the connected utility.
- BATT: Set battery type: ALK, NiMH or Li-ION and enable / disable Eco mode.
- MAX P: Set the transmitter to output its maximum wattage.
- MODEL: Match the transmitter setting to the model of your locator.
- MAX V: Set the output voltage to maximum (90V).
- ILOC: Enable, disable or pair iLOC connections (Bluetooth models only).

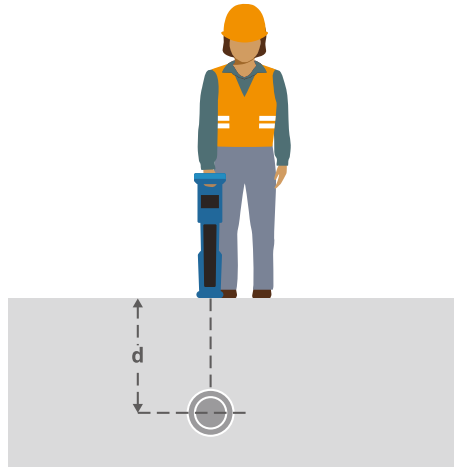

Locating with Active Frequencies

Active frequencies are applied to the target pipe or cable using the transmitter, and provide the most effective way of tracing buried pipes or cables.

Generally speaking, it is better to use a low frequency on larger, low impedance utilities, and move to a higher frequency on smaller, high impedance utilities.

The lowest power setting required to trace the target utility should always be used to minimize the risk of false trails.

The transmitter can apply a signal using three different methods:

Direct connection

In direct connection, you connect the transmitter directly to the pipe or cable you wish to survey using the red Direct Connect lead supplied. The black lead is generally connected to earth using the supplied ground stake.

Locating pipes and cables

For more detailed descriptions of using the locator and transmitter, and for detailed locate techniques, refer to the RD8200SG Operation Manual.

The RD8200SG locator is designed to operate with the 'blade' of the locator perpendicular to the path of the cable or pipe being located.

The transmitter will then apply a discrete signal to the line, which you can trace using the locator. This method provides the best signal on an individual line and enables the use of lower frequencies, which can be traced for longer distances.

⚠ WARNING! Direct connection to live conductors is POTENTIALLY LETHAL. Direct connections to live conductors should be attempted by fully qualified personnel only using the relevant products that allow connections to energized lines.

Induction

The transmitter is placed on the ground over or near the survey area. You select the appropriate frequency. The transmitter will then induce the signal indiscriminately to any nearby metallic conductor. In induction mode, using higher frequencies is generally recommended as they are induced more easily onto nearby conductors.

Transmitter Clamp

An optional signal clamp can be placed around an insulated live wire or pipe up to 5" / 215mm in diameter to transfer the transmitter signal to the utility. This method of applying the transmitter signal is particularly useful on insulated live wires and removes the need to disconnect the supply to the cable.

⚠ WARNING! Do not clamp around uninsulated live conductors.

⚠ WARNING! Before applying or removing the clamp around a power cable ensure that the clamp is connected to the transmitter at all times.

Locating with Passive Frequencies



Passive frequency detection takes advantage of signals that are already present on buried metallic conductors. The RD8200SG supports four types of passive frequencies: Power, Radio, CPS and Cable TV (CATV) signals. You can detect these frequencies without the aid of the transmitter.

Antenna Modes

The RD8200SG offers a choice of 5 antenna modes, each of which is designed for specific uses, depending on what task is being carried out.

To scroll between locate modes, press the  key.

 **PEAK:** For accurate locating, the peak bargraph provides a visual readout of the signal strength. The peak signal is found directly over the buried utility.

 **PEAK+:** Choose to combine the accuracy of the Peak bargraph with Null arrows, which can indicate the presence of distortion, or with proportional Guidance arrows for rapid line tracing – switch between them by holding the  key.

 **GUIDANCE:** Proportional arrows and a ballistic 'needle' combine with audio left/right indication for rapidly tracing the general path of a buried utility.

 **BROAD PEAK:** Operating similarly to Peak mode, but giving a result over a wider area. Used to detect and trace very weak signals, for example very deep utilities.

 **NULL:** Provides a quick left/right indication of the path of a utility. As Null is susceptible to interference, it is best used in areas where no other utilities are present.

The guidance on the use of the PointMan app by ProStar is correct to the best of our knowledge. Mobile apps evolve constantly and can change without notice. Please consult www.pointman.com for the latest information on the PointMan app and report any issues to support@prostarcorp.com

For a list of the importers of the RD8200SG into Europe, please visit:
<https://www.radiodetection.com/en/european-importers>

Copyright ©2023 Radiodetection Ltd. All rights reserved. Radiodetection is a subsidiary of SPX Technologies, Inc. RD8200SG, Power Filters, Peak+, eCert, StrikeAlert, SideStep, SideStepAuto, CALSafe, iLOC, Current Direction, RD Manager Online, RD Map+ and Radiodetection are either trademarks or registered trademarks of Radiodetection in the United States and / or other countries. The Bluetooth word mark and logos are owned by the Bluetooth SIG, Inc. and any use of such marks by Radiodetection is under license. Microsoft and Windows are either registered trademarks or trademarks of Microsoft Corporation in the United States and/or other countries. POINTMAN is a trademark of PROSTAR GEOCORP., INC. Due to a policy of continued development, we reserve the right to alter or amend any published specification without notice. Photos are indicative and products received may not be identical to those shown. This document may not be copied, reproduced, transmitted, modified or used, in whole or in part, without the prior written consent of Radiodetection Ltd.



Our Mission

Provide best in class equipment and solutions, to prevent damage to critical infrastructure, manage assets and protect lives.

Our Vision

To be the world's leader in the management of critical infrastructure and utilities.

Our Locations



USA

Raymond, ME
Kearneysville, WV

Canada

Mississauga, ON



Europe

United Kingdom HQ

France

Germany

The Netherlands



Asia Pacific

India

China

Hong Kong

Indonesia

Australia

Visit: www.radiodetection.com

Follow us on:    

Scan to see a full list of our office locations

